

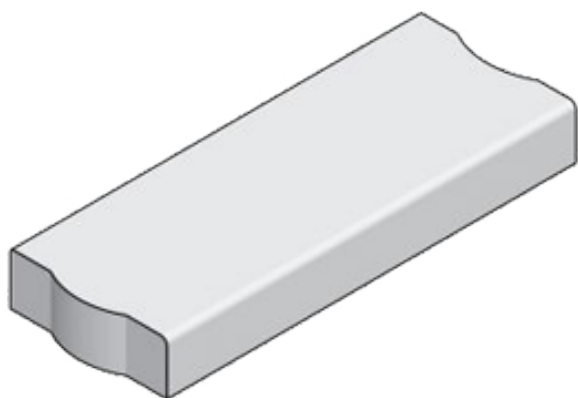

## Trottoirband 48x16

Trottoirbanden 48x16 zijn aan één zijde afgerond en kunnen dus als kantopsluiting gebruikt worden.



**Afmetingen en productvarianten**  
48x16 cm





## Trottoirband 48x16

### Kleurenoverzicht

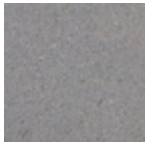

Grijs

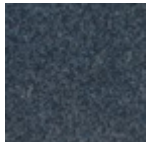

Hardsteen

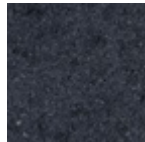

Zwart



Graniet



Gewassen basalt

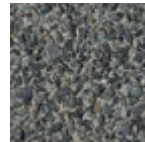

Groen-zwart

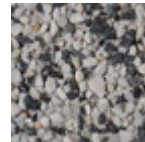

Wit-zwart

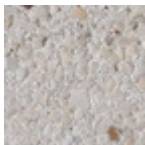

Wit

Zie website voor gedetailleerde beschikbaarheid.

### Productvarianten

		48x16
rechte band		x
bochten	r=4 uitw.	x
	r=5,5w.	x
	r=6 uitw.	x
	r=8 inw.	x
	r=12 uitw.	x
hoekset	90° uitw.	x
eindband	li/re	x