

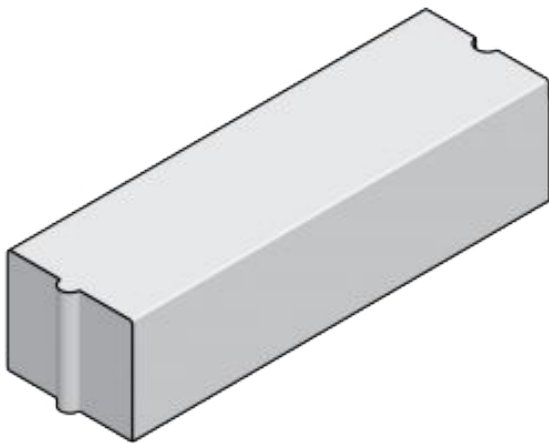

Rabatbanden

Rabatbanden worden, vanwege hun vlakke bovenzijde, gebruikt als scheiding van twee oppervlakken, als kantopsluiting of opsluitband.



Afmetingen en productvarianten

20x20 cm
30x15 cm
25x20 cm
30x20 cm
30x25 cm
40x20 cm
50x30 cm

Voor een overzicht van alle productvarianten zie pagina 3.





Rabatbanden

Kleurenoverzicht

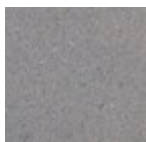

Grijs

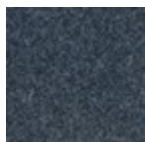

Hardsteen

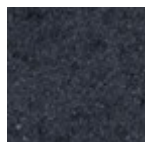

Zwart

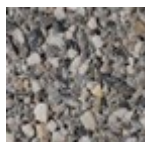

Graniet



Gewassen basalt



Groen-zwart

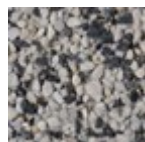

Wit-zwart

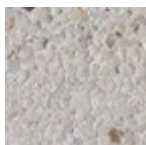

Wit

Zie website voor gedetailleerde beschikbaarheid.



Rabatbanden

Productvarianten

		20x20	25x20	30x15	30x20	30x25	40x20	50x30
rechte band	midden	x						
			x	x	x	x	x	x
bochten	r=0,5 uitw.						x	
	r=1 uitw.		x				x	
	r=2 uitw.		x				x	
	r=3 uitw.		x				x	
	r=4 uitw.	x			x			
	r=5 uitw.						x	
	r=6 uitw.		x		x	x	x	
	r=7 uitw.						x	
	r=8 inw.		x					
	r=8 uitw.	x					x	x
	r=10 uitw.	x	x			x	x	
	r=12 uitw.						x	x
	r=12,5 inw.						x	
	r=20 uitw.						x	
r=25 uitw.						x		
hoekstuk	90° uitw.		x				x	
	90° inw.		x					